

Katalogový list

platný od: 1/1/22

+GF+



Koleno 45° PE 100 SDR 11

- S prodlouženými konci
- 10 bar plyn / 16 bar voda
- * FM GLOBAL (FM 1613) - 15 bar

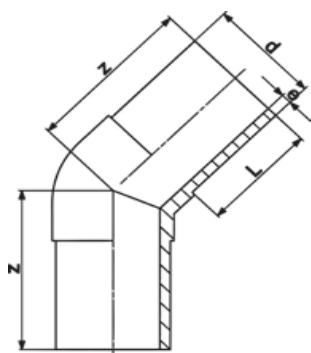

*	d (mm)	Obj. číslo	Hmotn. (kg)	L (mm)	z (mm)	e (mm)
	20	753 151 006	0.027	52	70	1.9
	25	753 151 007	0.037	52	75	2.3
	32	753 151 008	0.050	54	80	3.0
	40	753 151 009	0.086	57	85	3.7
	50	753 151 010	0.133	63	90	4.6
	63	753 151 011	0.227	65	95	5.8
	75	753 151 012	0.350	72	105	6.8
*	90	753 151 013	0.565	81	120	8.2
*	110	753 151 014	0.921	86	130	10.0
*	125	753 151 015	1.290	92	140	11.4
*	140	753 151 016	1.796	120	164	12.7
*	160	753 151 017	2.454	102	162	14.6
*	180	753 151 018	3.274	107	170	16.4
*	200	753 151 019	4.362	116	186	18.2
*	225	753 151 020	5.981	123	200	20.5
*	250	753 151 021	8.283	130	220	22.7
*	280	753 150 922	10.285	140	230	25.4
*	315	753 150 923	14.124	150	250	28.6

Technické údaje jsou nezávazné. Konstrukční a rozměrové změny vyhrazeny.
Platí naše všeobecné obchodní podmínky.